

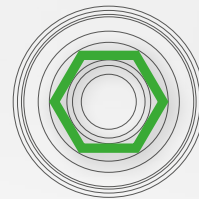

JDENTAL CARE
just smile

JD ZYGOMA

*A graftless solution for severe resorption
in maxillary bone*



hexagonal connection



designed for

Maxilla-For-All®



Made in Italy

JD ZYGOMA

A GRAFTLESS SOLUTION

+ Titanium Grade 4

+ High primary stability for the immediate function

Thanks to the multi-cortical anchorage and the design of the apex of the implant it's possible to obtain a high primary stability which allows you to provide to your patients a temporary prosthesis immediately after the surgery

+ Two optional diameters available: 3,9mm and 4,3mm

Get stability also in cases of rehabilitation of severely atrophic maxilla

+ A graftless solution

Using JDZygoma implant is possible to avoid complex bone graft procedures, with the advantage of reducing treatment and healing times.

JDZygoma implants are characterised by the hexagonal internal connection, a smooth body and a threaded tapered apex for a perfect anchorage in the zygomatic bone. The implant-abutment connection is compatible with JDEvolution Plus, resulting in the advantage of a greater prosthetic flexibility.

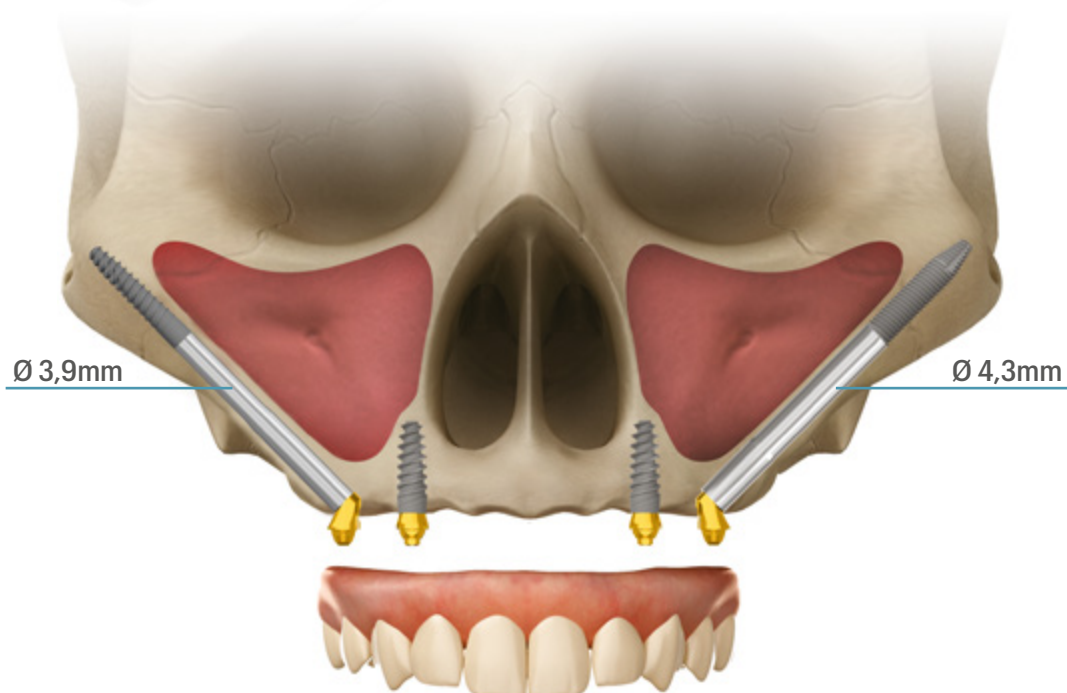
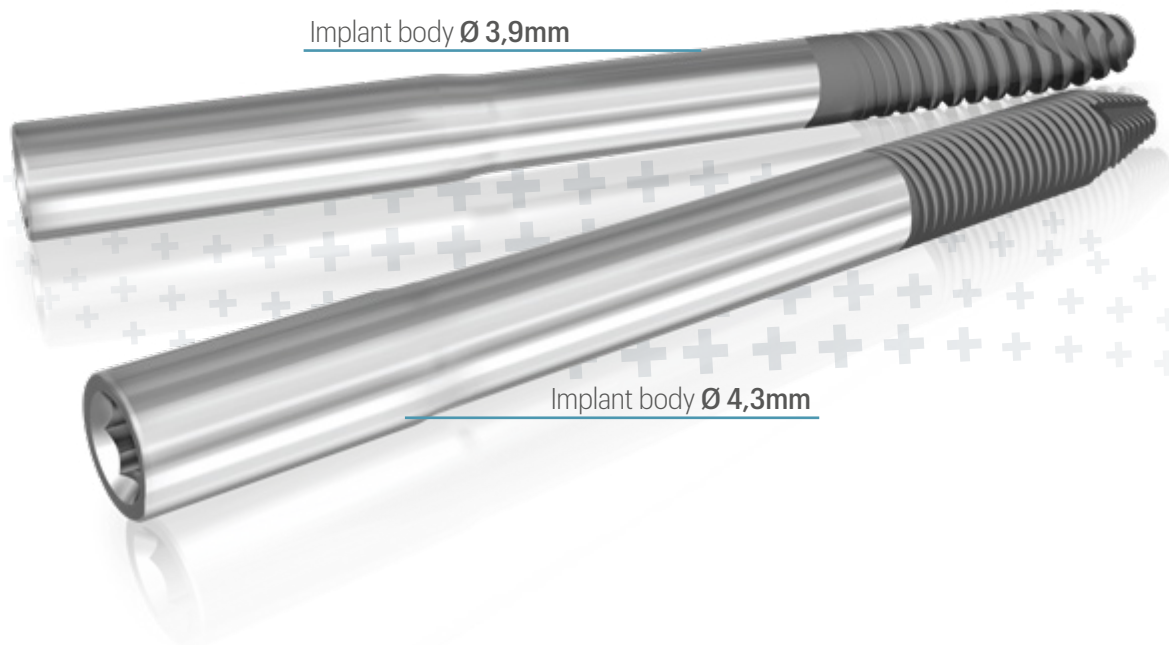

PRODUCT SPECIFICATION

The JDZygoma dental implants are available in the diameters and lengths shown in the following table:

CORONAL DIAMETER	IMPLANT DIAMETER	TIP DIAMETER	THREADED PART LENGTH	IMPLANT LENGTH
Ø 4,3	Ø 3,9	2,70	18,0	30
				35
				37.5
				40
				42.5
				45
				47.5
				50
				52.5
				55
Ø 4,5	Ø 4,3	2,14	18,0	30
				35
				37.5
				40
				42.5
				45
				47.5
				50
				52.5
				55
57.5				
60				

Note: All measurements in mm

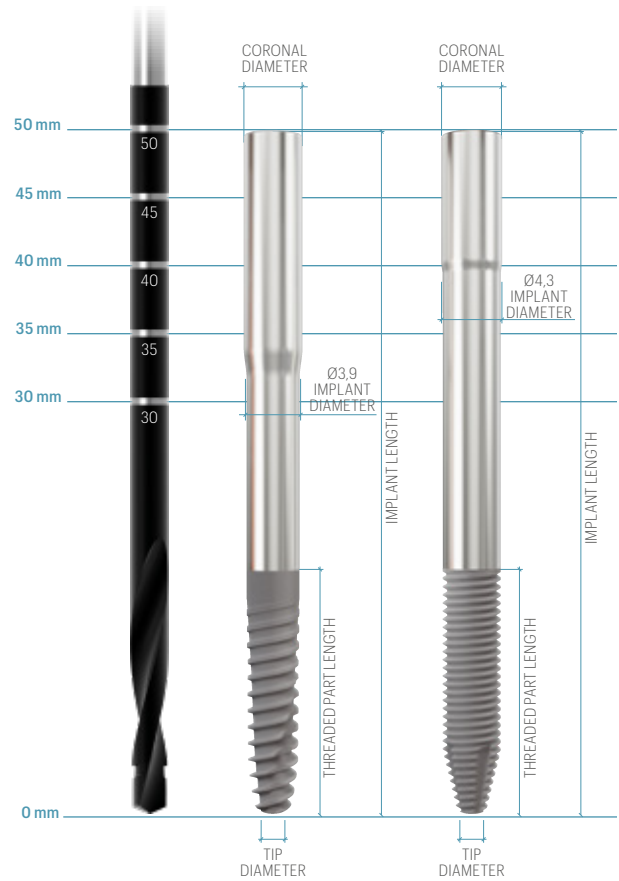

PRODUCT CATALOGUE

Implants:

Ø 3,9

- ZY39300: JDZygoma Ø 3.9 L 30
- ZY39350: JDZygoma Ø 3.9 L 35
- ZY39375: JDZygoma Ø 3.9 L 37.5
- ZY39400: JDZygoma Ø 3.9 L 40
- ZY39425: JDZygoma Ø 3.9 L 42.5
- ZY39450: JDZygoma Ø 3.9 L 45
- ZY39475: JDZygoma Ø 3.9 L 47.5
- ZY39500: JDZygoma Ø 3.9 L 50
- ZY39525: JDZygoma Ø 3.9 L 52.5
- ZY39550: JDZygoma Ø 3.9 L 55
- ZY39575: JDZygoma Ø 3.9 L 57.5

Ø 4,3

- ZY43300: JDZygoma Ø 4.3 L 30
- ZY43350: JDZygoma Ø 4.3 L 35
- ZY43375: JDZygoma Ø 4.3 L 37.5
- ZY43400: JDZygoma Ø 4.3 L 40
- ZY43425: JDZygoma Ø 4.3 L 42.5
- ZY43450: JDZygoma Ø 4.3 L 45
- ZY43475: JDZygoma Ø 4.3 L 47.5
- ZY43500: JDZygoma Ø 4.3 L 50
- ZY43525: JDZygoma Ø 4.3 L 52.5
- ZY43550: JDZygoma Ø 4.3 L 55
- ZY43575: JDZygoma Ø 4.3 L 57.5
- ZY43600: JDZygoma Ø 4.3 L 60

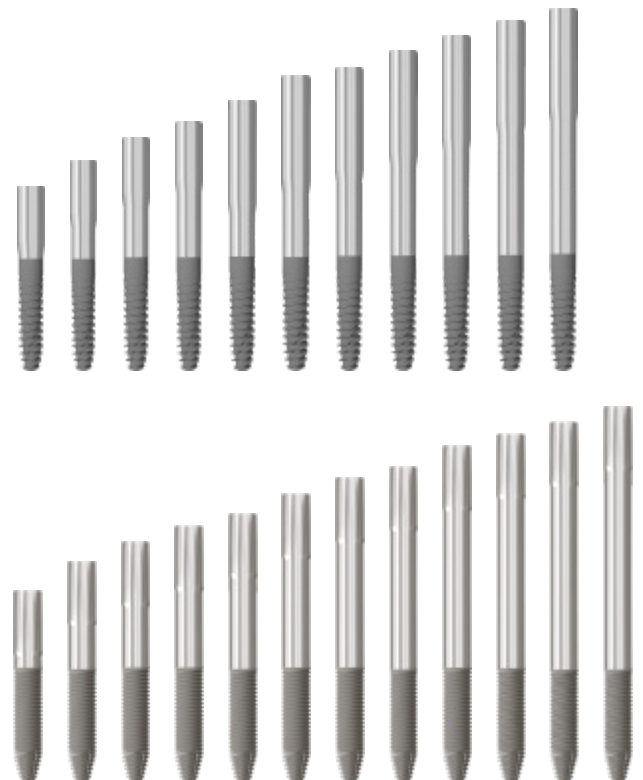

Drills and Depth probe:

JDDRZSF28	Round Bur Drill Ø 2.8 JDZygoma
ZJDDRID50	Initial Drill L 50 JDZygoma
ZJDDREXS150NP	Initial Drill L 50 New Profile JDZygoma
ZJDDREXS170NP	Initial Drill L 70 New Profile JDZygoma
JDDIADR	Diamond Drill JDZygoma
JDDIADRL	Diamond Drill Long JDZygoma
ZJDDR28	Drill Ø 2.8 JDZygoma
ZJDDR28L	Long Drill Ø 2.8 JDZygoma
ZJDDR32	Drill Ø 3.2 JDZygoma
ZJDDR32L	Long Drill Ø 3.2 JDZygoma
ZJDDR36	Drill Ø 3.6 JDZygoma
ZJDDR36L	Long Drill Ø 3.6 JDZygoma
ZJDDREXS150N	Zygomatic Drill 1 L 50 - 3 Flutes
ZJDDREXS170N	Zygomatic Drill 1 L 70 - 3 Flutes
ZJDDREXS250N	Zygomatic Drill 2 L 50 - 3 Flutes
ZJDDREXS270N	Zygomatic Drill 2 L 70 - 3 Flutes
ZJDDREXS350N	Zygomatic Drill 3 L 50 - 3 Flutes
ZJDDREXS370N	Zygomatic Drill 3 L 70 - 3 Flutes
JDZPR	60mm Depth Probe JDZygoma

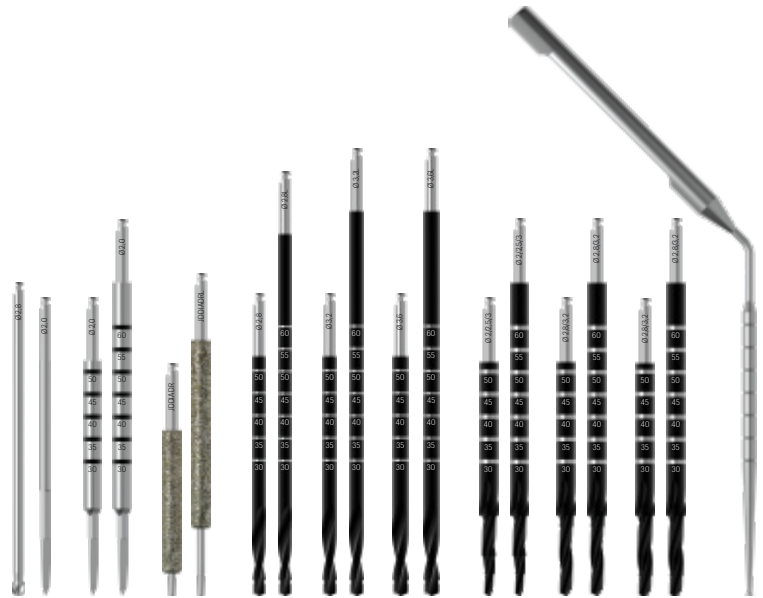

Conical abutment:

EVCA4545C:	Conical Abutment Angulated 45° H 4.5 JDEvolution Plus
EVCA4560C:	Conical Abutment Angulated 45° H 6.0 JDEvolution Plus
EVCA5250C:	Conical Abutment Angulated 52.5° H 5.0 JDEvolution Plus
EVCA6050C:	Conical Abutment Angulated 60° H 5.0 JDEvolution Plus
EVCASA:	Screw for Angulated Conical Abutment JDEvolution Plus
EVCASA60:	Screw for 60° Angulated Conical Abutment JDEvolution Plus
EVCAPS:	Prosthetic Screw Conical Abutment JDEvolution Plus
EVCAPSL:	Prosthetic Screw Conical Abutment Long JDEvolution Plus
EVCAPSA	Prosthetic Screw Angulated for Conical Abutment JDEvolution
EVCAICOTEC:	Conical Abutment Impression Coping Engaging Open Tray JDEvolution Plus
EVCAICOTC:	Conical Abutment Impression Coping Open Tray JDEvolution Plus
EVCAICOTLC:	Conical Abutment Impression Coping Open Tray Long JDEvolution Plus
EVCAICOT02:	Screw for Conical Abutment Impression Coping Open Tray JDEvolution Plus
EVCAICOT04:	Screw for Conical Abutment Impression Coping Open Tray Long JDEvolution Plus
EVCAICTC	Conical Abutment Impression Coping Closed Tray
EVCAHC:	Healing Cap for Conical Abutment JDEvolution Plus
EVCAHCL:	Conical Abutment Healing Cap H 6.0 JDEvolution Plus
EVCAHC9:	Conical Abutment Healing Cap H 9.0 JDEvolution Plus
EVCAHCB:	Conical Abutment Healing Cap Peek JDEvolution Plus
EVCAGPAEC:	GP Abutment Engaging for Conical Abutment JDEvolution Plus
EVCAGPANEC:	GP Abutment Non Engaging for Conical Abutment JDEvolution Plus
EVCATANEC:	Temporary Abutment Non Engaging Conical Abutment JDEvolution Plus
EVCATANEWC:	Temporary Abutment Non Engaging Conical Abutment for Welding JDEvolution Plus
EVCAWANEC:	Wax-Up Abutment Non Engaging for Conical Abutment JDEvolution Plus
EVCAAR	Conical Abutment Replica

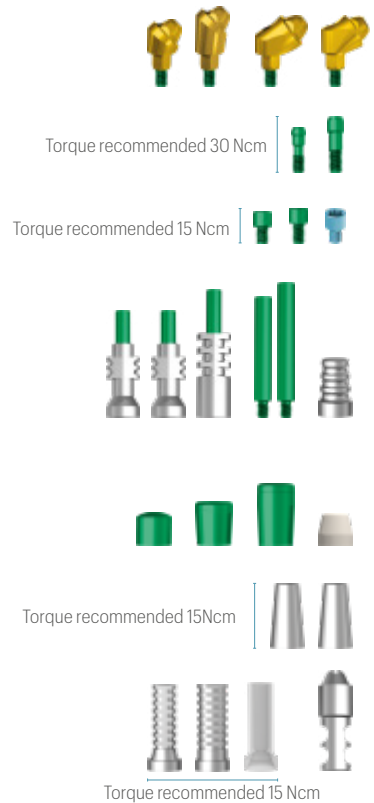

JDScanBody, Interface and Abutment Replica CAD CAM for Conical abutment:

EVSBECEC:	ScanBody Engaging JDEvolution Plus
EVCASBECEC:	ScanBody Conical Abutment JDEvolution
EVCASBECEC:	ScanBody Engaging Conical Abutment JDEvolution Plus
EVCASBCEC:	On Top ScanBody Conical Abutment JDEvolution Plus
EVCATEC:	Interface CAD CAM Engaging for Conical Abutment JDEvolution Plus (H 7.5)
EVAI39C:	TiBase Engaging for Conical Abutment JDEvolution Plus (H 5.0)
EVCATEC:	Interface CAD CAM Non Engaging for Conical Abutment JDEvolution Plus (H 7.3)
EVCATIBC:	TiBase for Conical Abutment JDEvolution Plus (H 5.0)
EVCAARC	Conical Abutment Replica CAD CAM



Implant and Prosthetic Drivers:

EVID:	Implant Driver JDEvolution Plus
EVIDL:	Implant Driver Long JDEvolution Plus
EVSDPF15:	Prosthetic Driver for JDTorque L 15 JDEvolution Plus
EVSDPF20:	Prosthetic Driver for JDTorque L 20 JDEvolution Plus
EVSDPF25:	Prosthetic Driver for JDTorque L 25 JDEvolution Plus
EVSDPF35:	Prosthetic Driver for JDTorque L 35 JDEvolution Plus
EVSDPF60:	Prosthetic Driver for JDTorque L 60 JDEvolution Plus
EVSDCAF	Conical Abutment Driver for JDTorque
EVSDP20:	Prosthetic Driver L 20 JDEvolution Plus
EVSDP25:	Prosthetic Driver L 25 JDEvolution Plus
EVSDP30:	Prosthetic Driver L 30 JDEvolution Plus
JDPD105	Prosthetic Driver JDEvolution Plus for Surgical Driver
EVSDCA	Conical Abutment Drive
EVSDPF25A	Angulated Screw Driver for JDTorque L 25
EVSDPF30A	Angulated Screw Driver for JDTorque L 30
EVSUD	Surgical Driver JDEvolution
EVSUDMAX	Surgical Driver MAX
JDID102	ZAPA Tool

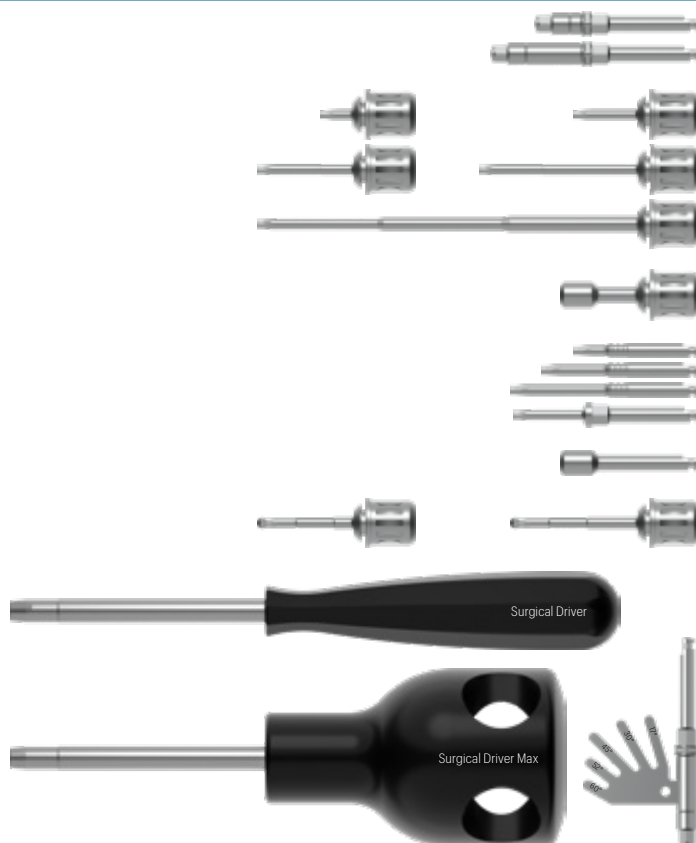

JD Zygoma Surgical Kit:

ZSKITE	JDZygoma Kit Extra
ZSKITF	JDZygoma Kit Full

JDZygoma connection is compatible with JDEvolution Plus implant line, so please refer to JDEvolution Plus catalogue to choose the most suitable component

SITE PREPARATION SEQUENCE

For the preparation of the implant site for the insertion of JDZygoma implants it is recommended to adhere to the following drilling sequences to ensure optimal primary stability of the implants.

JDZygoma Ø 3.9mm

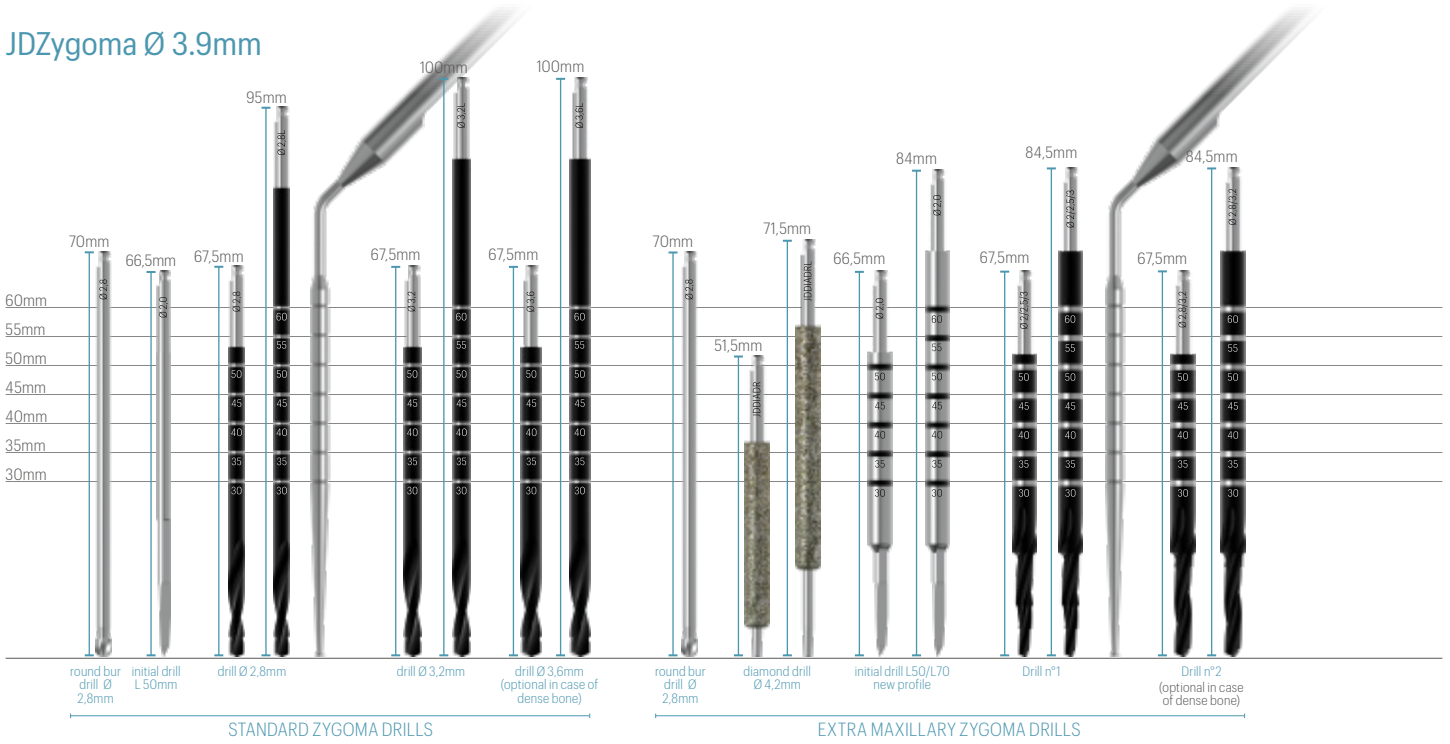

JDZygoma Ø 4.3mm

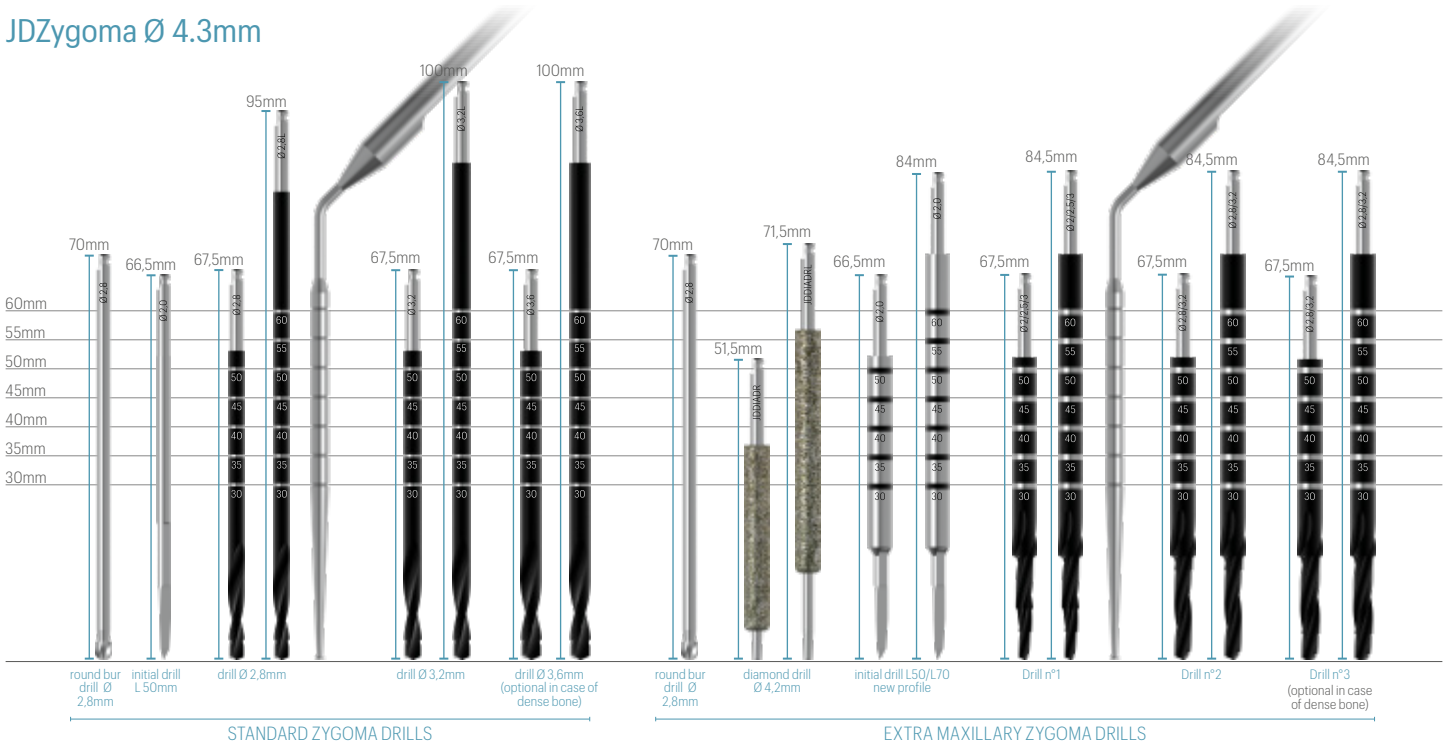

JDentalCare, the JDentalCare logo and other trademarks mentioned in this document are, excluding specifically mentioned exceptions, trademarks property of JDentalCare.

The images of the products represented in this brochure are not necessarily to scale.

Note: Not all products manufactured by JDentalCare and represented in this brochure have been regulatory cleared/released for sale in all countries and/or have been licensed in accordance with FDA Rules and Regulations.

For more information about current product assortment and availability, please contact your local JDentalCare distributor. For prescription only.

Caution: Federal (US) law restricts this device to sale by or on the other for a licensed dentist. See instructions for use for more information such as indications, warnings, precaution and contraindications.

REV.19 of 2024-03-19